

W-300 Thermal Label Printer User's Guide

**for Wasp Bar Code Technologies®
DT/TT Printer**



© Copyright Wasp Bar Code Technologies 2001.
All rights reserved.

No part of this publication may be reproduced or transmitted in any form or by any means without the written permission of Wasp Bar Code Technologies. The information contained in this document is subject to change without notice.

Wasp is a trademark of Wasp Bar Code Technologies. All other trademarks or registered trademarks are the property of their respective owners.

Table of Contents

Quick Setup Guide

	Inspecting the Printer	1
	Connection Diagram.....	2
	Connecting the Printer	3
	Loading the Ribbon.....	4-8
	Loading the Media.....	9-13
	Calibrating the Printer.....	14
Chapter 1	Operator Controls.....	15
Chapter 2	Resetting the Printer.....	16
Chapter 3	Printer Driver.....	17
Chapter 4	Setting Printer Properties	18-19
Chapter 5	Troubleshooting.....	20-22
Chapter 6	Printer Maintenance	23
Chapter 7	Technical Specifications	24
Chapter 8	Product Support & Warranty Information	25

Inspecting the Printer

After removing the printer from the packaging material, check the contents of the package. The following items should be included:

- Wasp Bar Code Printer
- AC Power Supply
- CD Rom Disk
- Sample Media
- Sample Ribbon
- Parallel Printer Cable

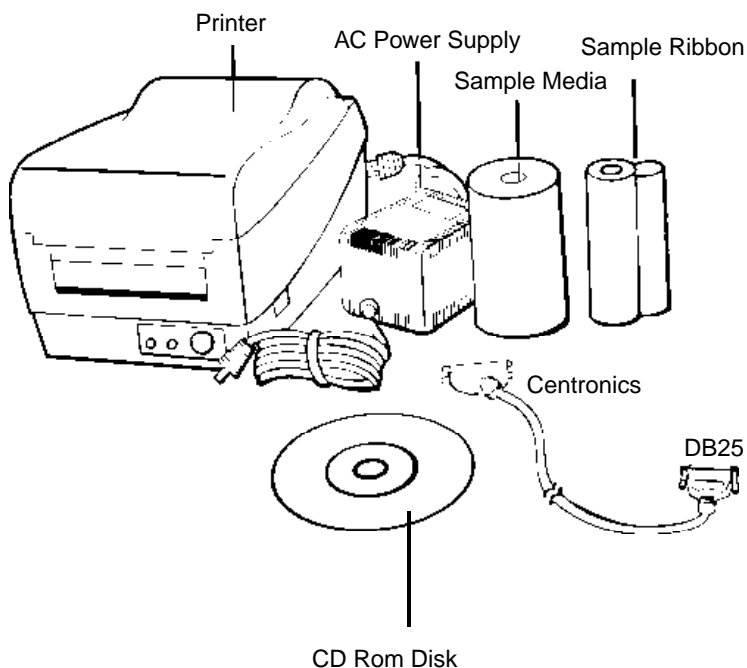

Quick Setup Guide

Connection Diagram

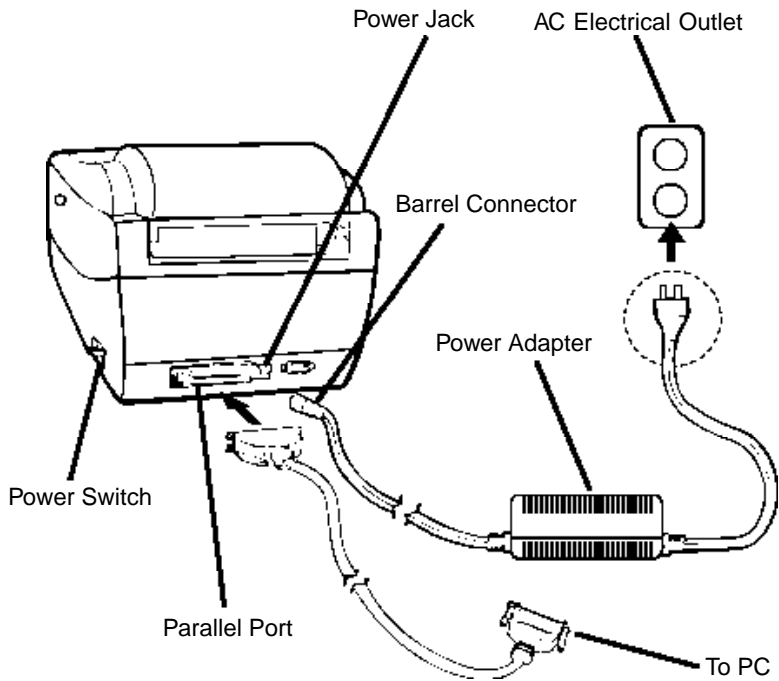

Power Supply

Note: The power supply must be connected into the back of the printer before connecting the communication cables.

1. The Power Adapter has a barrel connector on one end that must be inserted into the power jack on the back of the printer.
2. Plug the other end of the cord into an appropriate 120V AC electrical outlet.

Parallel Interface Requirements

Note: This printer complies with FCC “Rules and Regulations”, Part 15, for Class B Equipment, using fully shielded six-foot data cables. Use of longer cables or unshielded cables may increase radiated emissions above the Class B limits.

The included cable (IEE 1284-compliant) has a standard 36-pin parallel connector on one end, which is plugged into the parallel port located on the back of the printer. The other end of the parallel interface cable connects to the parallel port on the host computer.

Data cables must be of fully shielded construction and fitted with metal or metalized connector shells. Shielded cables and connectors are required to prevent radiation and reception of electrical noise.

To minimize electric noise pickup in the cable:

1. Keep data cables as short as possible (6 feet recommended).
2. Do not tightly bundle the data cables with power cords.
3. Do not tie the data cables to power wire conduits.

Quick Setup Guide

Loading the Ribbon

Loading the Ribbon

Note:

This section is not applicable to Direct Thermal (DT) printing.

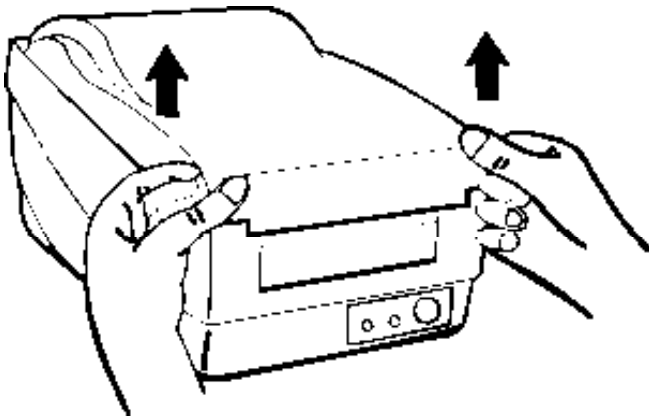

1. Lift the top cover to expose the media compartment.

Quick Setup Guide

Loading the Ribbon

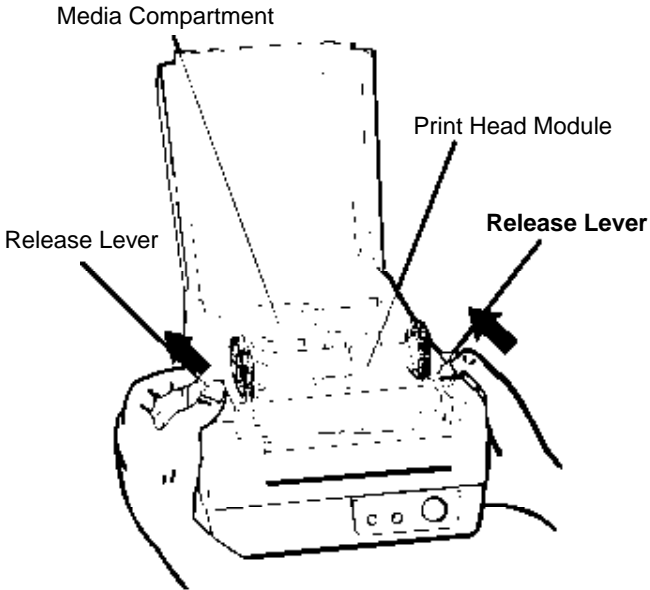

2. Unlatch the print head module by pushing the two white release levers on the sides of the print head module.

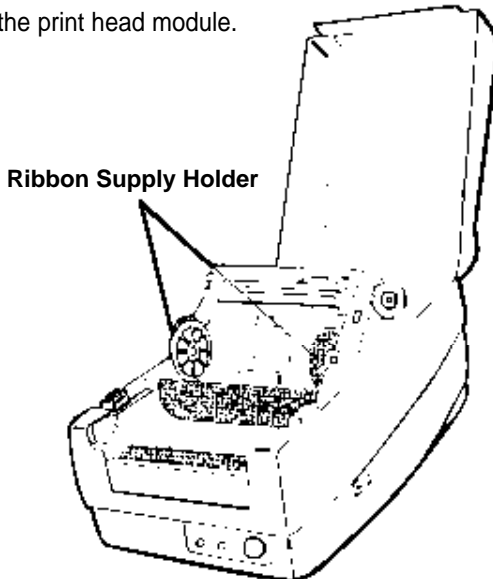

3. Turn over the print head module to expose the ribbon supply holder.

Quick Setup Guide

Loading the Ribbon

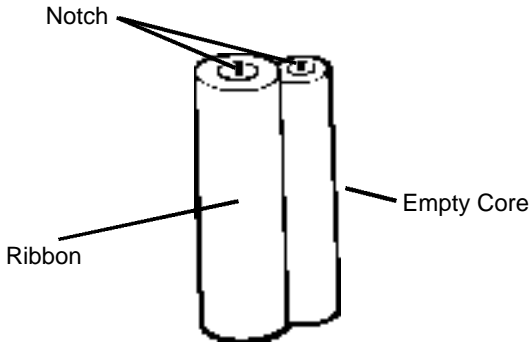

4. Unwrap the ribbon package and separate the ribbon roll and the empty core.

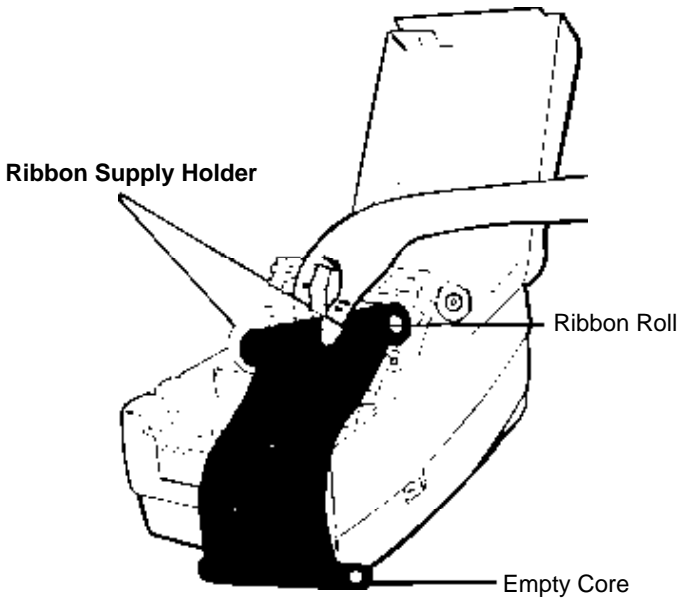

5. Insert ribbon into the internal ribbon supply holder. (First snap in left side by aligning notches in the core to the notches on supply wheel. Then snap in right side.)

Quick Setup Guide

Loading the Ribbon

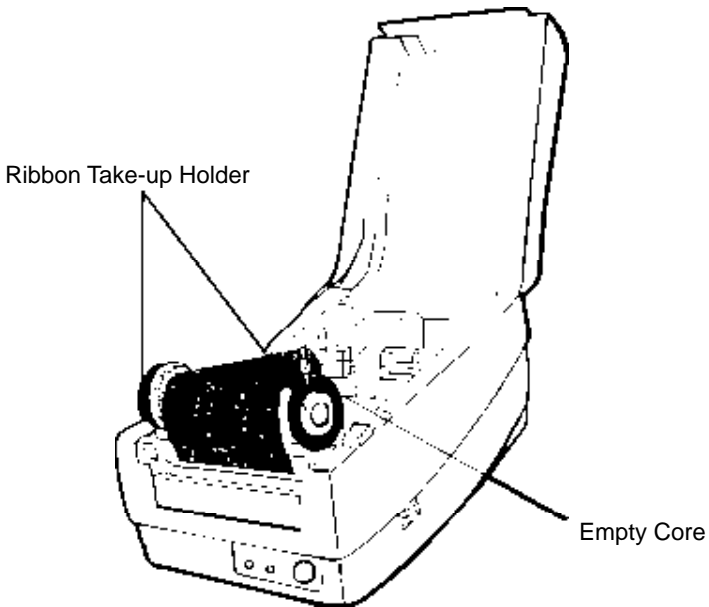

6. Insert empty core into the outer ribbon supply take-up holder. (First snap in left side by aligning notches in the core to the notches on the take-up wheel. Then snap in the right side.)

Quick Setup Guide

Loading the Ribbon

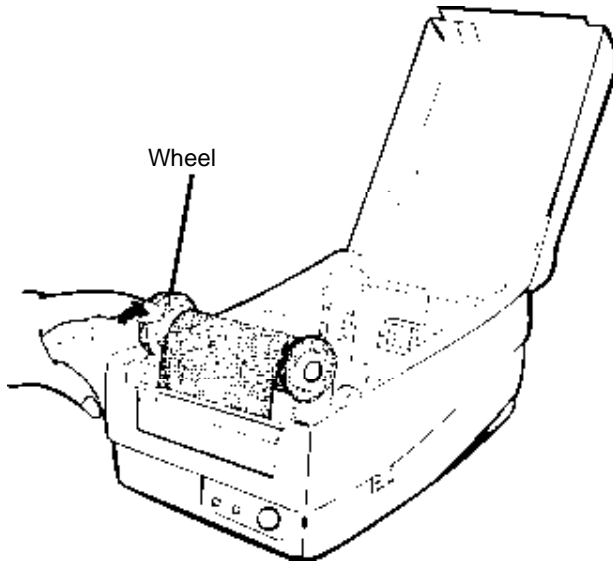

7. Turn the take-up wheel forward and rewind the excess ribbon.

Quick Setup Guide

Loading the Media

Standard Mode - (Direct Thermal and Thermal Transfer)

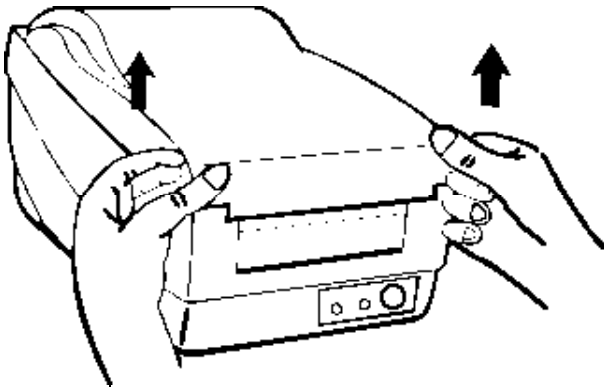

1. Lift the top cover to expose the media compartment.

Quick Setup Guide

Loading the Media

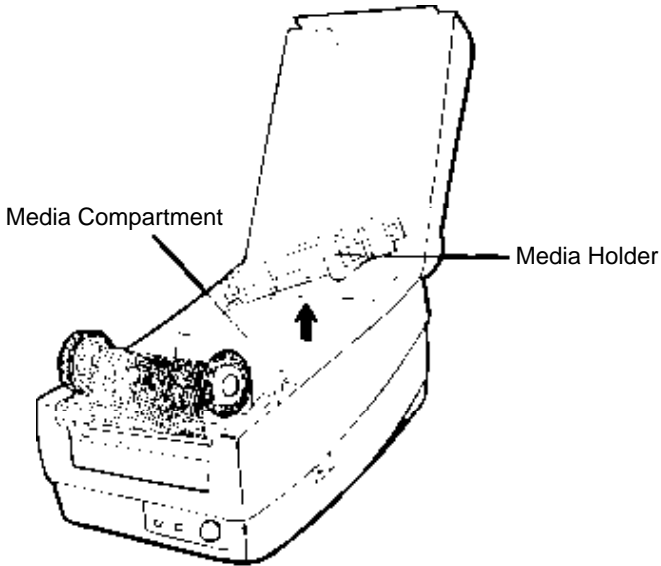

2. Remove the media holder.

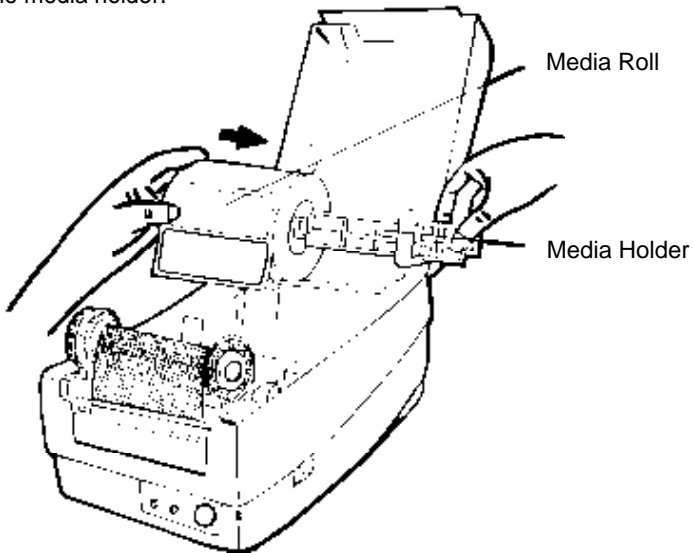

3. Load the media roll onto the holder from the left.

Quick Setup Guide

Loading the Media

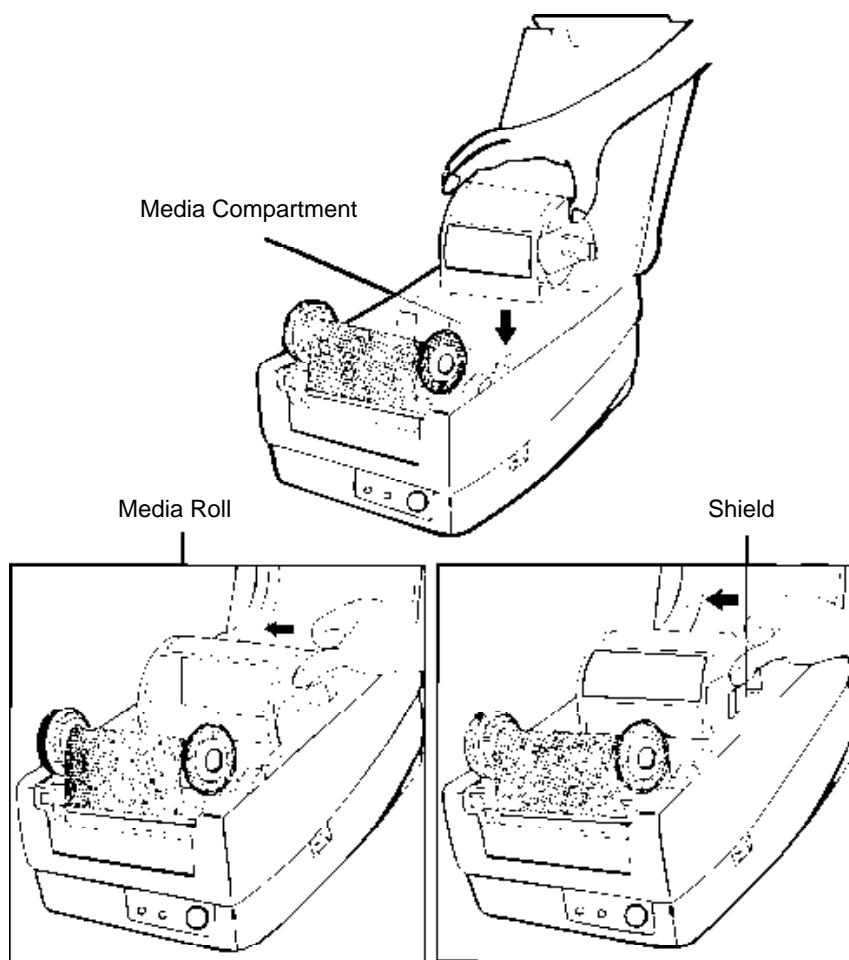

4. Place the media holder back to the media compartment.
5. Move the media roll to the left end of the holder.
6. Slide the shield snug against the media.

Quick Setup Guide

Loading the Media

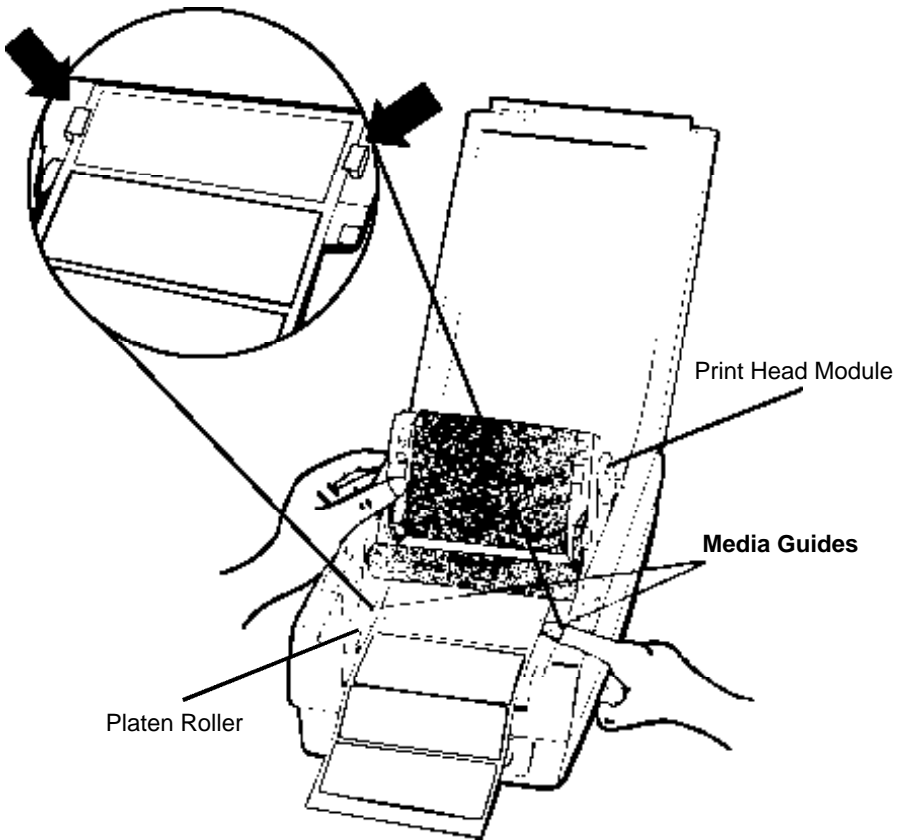

7. Hold the print head module upright with one hand to allow the media to pass under it. Lead the media through the media guides with the other hand. Right side slides in and out.
8. Lead the media over the platen roller

Quick Setup Guide

Loading the Media

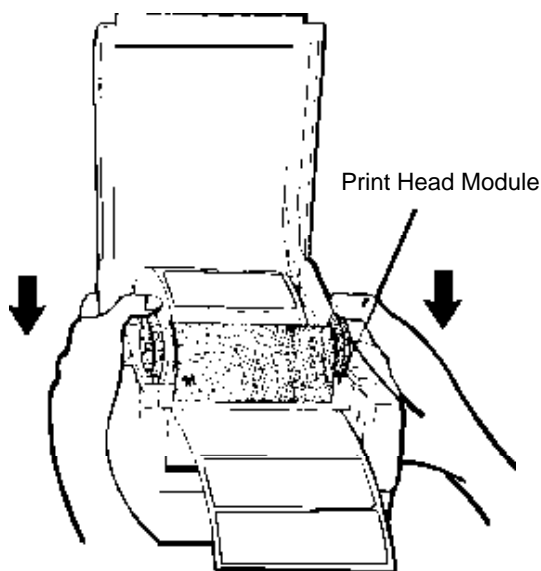

9. Press down firmly on the outside edges of the supply holder to securely lock into place. You will hear it "click" shut

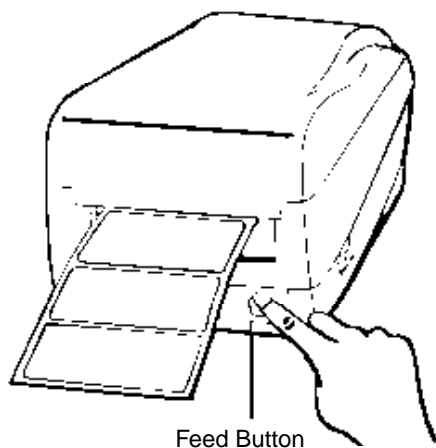

10. Close the top cover and turn on the printer or press the feed button if the printer is already on.

Quick Setup Guide

Calibrating the Printer

Performing Calibration

Note: This step is very important and must always be carried out whenever media is being changed. Failure to do so will result in mis-detection of the label size.

1. Press and hold the feed button while turning on the power until the printing motor becomes activated.
2. The calibration is complete when the printer automatically feeds the label stock.
3. Press feed button one more time to line label up for printing.

Printing Configuration Report

1. Press and hold the feed button while turning on the power.
2. Continue holding down the feed button. The printer will begin to feed approximately 12" of blank media. The printer will then print a configuration report. This report states the firmware version, ROM checksum, RS232, thermal transfer/direct thermal settings, hardware configuration and font types.

Operator Controls

Power Switch - Controls printer power

On - normal operation

Off - the power should be turned off before connecting or disconnecting the communication cables and power cables

Feed Button - Advances the media to the printing position

Press - to advance a label

Press - takes the printer out of a "pause" condition

Press and hold while turning on the power to print out the configuration profile

Ready Indicator - Shows the printer status

Green - printer is ready to operate

Blinking - printer is paused

Power Indicator - Shows the power and error status

Off - printer power off

Green - printer power on

Blinking - error

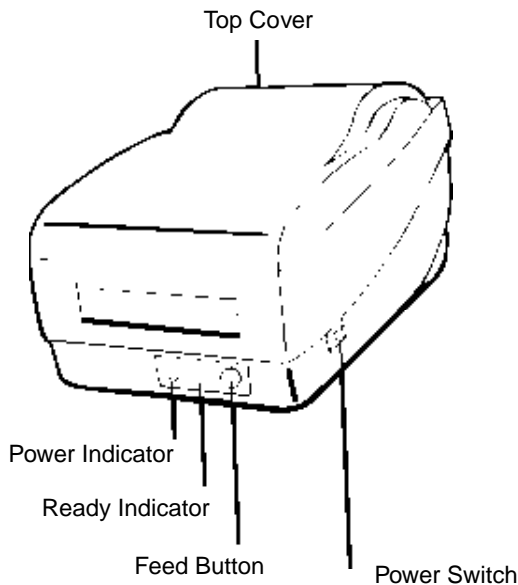

Resetting the Printer to Factory Default Settings

1. Turn on the printer and wait for approximately 5 seconds.
2. Press the “Feed” button for 10 seconds. The “Ready” indicator and “Power” indicator will go off in order.
3. When the two indicators become lit again, release the feed button.
4. At this moment, the printer will feed 12 inches of label stock, and will reset itself to the factory default settings.

Note: All settings are stored in non-volatile EPROM and cannot be erased when the printer is turned off.

Printer Driver

The bundled printer driver is compatible with Windows 2000/ME/9x, and Windows NT. Through this driver you may print using any Windows software application that supports Windows printing.

Installing Driver

1. Click the **Start**, point to **Settings**, click **Printers**, and then double-click **Add Printer**.



2. Click **Network** or **Local** and then click **Next**.
3. Click **Have Disk**, click the pull-down menu to select CD ROM (or floppy disk) drive path.
4. Click **Browse**.
5. Select the proper operating system for installation:
 - WIN95
 - WIN98
 - WIN2000
 - NT4.0
6. The driver name will appear in the “List of Printers,” click **Next**.
7. Select the communication port for the label printer. For parallel port, select “LPT1:,” “LPT2:” or “LPT3:,” for serial port, select “COM1:” or “COM2:”.
8. After the related files have been copied to your system, the installation is complete.

Chapter 4

Setting Printer Properties

Setting Printer Properties

After installing the driver, follow the steps below to modify the printer properties:

1. Click **Start**, point to **Settings**, and then click **Printers**.
2. Right-click the icon for the printer you are using and then click **Properties**.



The properties include:

Ports

Select the IO port you are printing to. This port may be parallel (LPT), serial (COM), network port or file.

Paper Size

Select your label size from the menu. If your size is not listed, select "Custom" to define your paper size.

Orientation

Set portrait or landscape according to the print direction.

Paper source (Media type)

T/T stands for Thermal Transfer (ribbon) mode and D/T for Direct Thermal mode (without ribbon).

Media choice (Darkness)

Some printing applications require changes to the darkness setting. This setting actually controls the heat intensity of the printhead. The lowest setting is 0; the highest intensity setting is 15.

Note: In most cases, direct thermal media requires a higher printhead heat than thermal transfer printing.

Note: Use the lowest intensity setting possible for your application. Printing at the lowest intensity will reduce the printhead wear.

Copies

This function designates the number of printed copies of each page.

Device options (Speed)

Use the pull down menu to choose the appropriate speed for your printing application. Speed is measured in inches per second from 1.0 ips to 3.0 ips.

Note: Speed will directly affect print quality: the slower the speed the longer the media will travel under the print head. For example, direct thermal media is heat activated; therefore, the label will be more reactive the longer the print head makes contact with the media.

Note: In most cases, use the slowest speed to achieve the highest print quality.

Troubleshooting

Normally, when the printer has an error, the “Power” or the “Ready” LED will blink.

To understand the problem, please check both LEDs first:

A. Power and Ready LEDs blink at the same time

Possible Problems	Solutions	Refer to Pages
Mis-detected the label gap.	<ul style="list-style-type: none">• Check the label path• Check the label sensor	10-14
Label stock empty	<ul style="list-style-type: none">• Reload labels	10-14
Label stock not installed properly	<ul style="list-style-type: none">• Reinstall the label roll	10-14
Label jam	<ul style="list-style-type: none">• Check media path and print head for possible media errors	10-14

B. Power and Ready LEDs blink alternately

Possible Problems	Solutions	Refer to Pages
Ribbon empty	<ul style="list-style-type: none">• Reload ribbon	5-9
Ribbon jam	<ul style="list-style-type: none">• Reload labels• Check media and ribbon	5-9
Ribbon sensor error	<ul style="list-style-type: none">• Call tech support	N/A

C. Only the Power LED blinks

Possible Problems	Solutions
Serial IO error	<ul style="list-style-type: none">• Check the baud rate
Memory full	<ul style="list-style-type: none">• Close all applications that are not needed for printing
Hardware error	<ul style="list-style-type: none">• Call tech support

Chapter 5

Troubleshooting

D. Miscellaneous

The PC says "Printer Time Out"

1. Make sure the communications cable (parallel or serial) is connected securely to the parallel or serial port on the PC and the printer.
2. Make sure the printer power is turned on.

If the data has been sent, but there is no output from the printer

Check the active printer driver and make sure the label printer has been selected.

Vertical streaks in the printout usually indicate a dirty or faulty print head

Example:

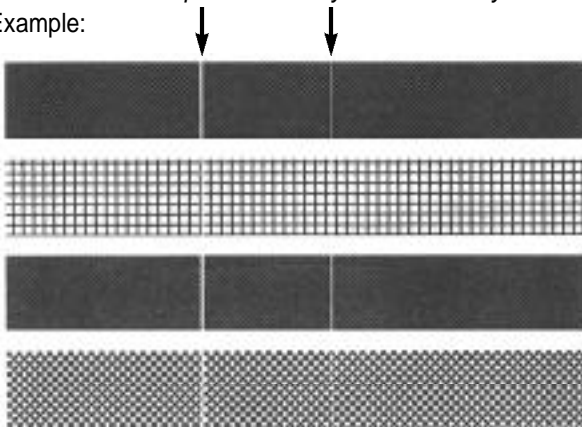

Clean the print head first. If the lines still persist, then the print head may need to be replaced.

Poor print quality

1. Adjust the Darkness (heat temperature) in the Windows printer driver.
2. Slow down the print speed.
3. Refer to the next chapter and clean the related spare parts.



Clean the following areas of the printer after 8 rolls of labels have been used. In each case, use a cotton swab dampened with alcohol. Do not soak the cotton swab excessively. These supplies can be purchased from Wasp Bar Code Technologies. Please call 214-547-4100 for details.

Note: Always switch off the power before cleaning.

Cleaning

Thermal Print Head

Thermal paper stock and ribbons will release debris on the print head and degrade printing quality. Clean the print head with methanol or isopropyl alcohol with a cotton swab. Do not touch the heater element with your fingers.

Paper Sensor

Debris or dirt on the paper sensor will cause a mis-read or incorrect detection of the label gap. Clean with a cotton swab dampened with alcohol.

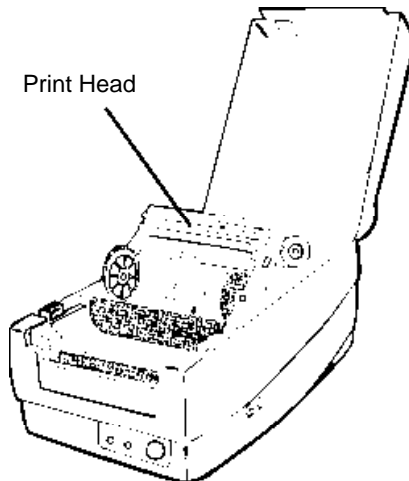

Chapter 7

Technical Specifications

Model	W-300 Thermal Transfer Printer
Print Method	Direct Thermal or Thermal Transfer
Resolution	203 DPI
Print Width	Up to 4"
Maximum Length	45"
Print Speed	3 IPS (Inches Per Second)
Memory	512K Standard
Dimensions	7.3" W x 10.9" D x 6.0" H
Weight	3.74 lbs
Electrical	FCC Class B, 19 VAC, 24 DC (2.5 A) 50/60 Hz (E, UL and CU Approved)
Operating Temperature	40°F – 100°F (4°C – 38°C)
Storage Temperature	40°F – 140°F (4°C – 60°C)
Humidity	15 – 85% RH
Ribbons	Wax, Wax Resin, and Resin
Labels	Direct Thermal and Thermal Transfer (various)

Product Support

If you experience any problems with your Wasp W-300 Printer that you are unable to resolve, call for technical assistance at (214) 547-4100, Monday through Friday, 8:00 AM - 5:00 PM Central Standard Time. Our web site is

www.waspbarcode.com

You may also contact us in writing at:

Wasp Bar Code Technologies
1400 10th Street
Plano, TX 75074
(214) 547-4100
(214) 547-4101 Fax

Warranty Information

Wasp W-300 Printer is warranted against defects in workmanship and materials for a period of one year from the date of shipment, provided that the product remains unmodified and is operated under normal and proper conditions.

Note: W-300 print heads are warranted for 90 days against defect in workmanship. Print heads will be replaced during the 90 day period once it is determined that the print head is defective.

This warranty is limited to repair or replacement at Wasp Technologies' option, with reasonable promptness after being notified. These provisions do not prolong the original warranty term for any product which has been repaired or replaced by Wasp Technologies.

This warranty applies to the original owner and does not extend to any product which has been subject to misuse, neglect, accidental damage, unauthorized repair, or tampering.

No other express warranty is given. The replacement or repair of a product is your exclusive remedy. Any other implied warranty of merchantability or fitness is limited to the duration of this written warranty. Some states, provinces, and countries do not allow how long an implied warranty lasts, so the above limitation may not apply to you.

In no event shall Wasp Technologies be liable for consequential damages. Some states, provinces, and countries do not allow the exclusion or limitation of incidental or consequential damages, so the above limitations may not apply to you.

